CVG-M

Installation Guide



SerVision

February
2011

Trademarks & Copyright

Trademarks

All trademarks mentioned in this manual are the sole property of their respective manufacturers.

Copyright

SerVision Ltd., Jerusalem, Israel

www.servision.net • info@servision.net

© 2011 SerVision Ltd. All rights reserved.

Notice

Information in this document is subject to change without notice. SerVision Ltd. assumes no responsibility for any errors that may appear in this manual. Companies, names and data used in examples herein are fictitious unless otherwise noted. No part of this document may be copied or reproduced in any form, or by any means, electronic or mechanical, for any purpose, without the express written permission of SerVision Ltd. SerVision Ltd. makes no warranties with respect to this documentation and disclaims any implied warranties of merchantability or fitness for a particular purpose.

Table of Contents

Introduction	3
The CVG-M Package	4
Additional Equipment	6
Installing the CVG-M System	7
Selecting a Location for the Unit	7
Preventing Overheating	8
Diagrams of Connectors	8
Supplying Power to Devices Connected to the Unit	10
Turning the Device Power On and Off with the Ignition	11
Transforming the Supplied Voltage to 12V	11
Configuring the Power-Supply Activator	12
Connecting Devices to the CVG-M	13
Connecting Cameras	13
Connecting a PTZ Controller	13
Connecting Sensors	15
Connecting a Sensor Directly to the Unit	15
Connecting Sensors Using an ADAM Module	16
Connecting an Activator	19
Connecting Sensors and Activators Using an IA Relay Board	20
Connecting a Microphone	21
Connecting a Speaker or Headphones	22
Connecting a CCTV Monitor	22
Connecting a Switch	24
Connecting Multiple Monitors	24
Connecting the CVG-M to a Network	25
LAN Connection	25
Cellular Connection	25
Connecting the Cellular Antenna	25
Inserting the SIM Card	25
Connecting the GPS Antenna	27
Connecting the CVG-M to a Power Source	28
Connecting the CVG-M to a Vehicle Battery	28
Connecting the CVG-M to an Electrical Outlet	31
Appendix: Removing the Micro SD Card	32
Removing the Micro SD Card from the Unit	32
Inserting a Micro SD Card into the Unit	32

Introduction

This guide explains how to set up the hardware components of SerVision's CVG-M security system. The CVG-M belongs to SerVision's line of TVG video gateway units. These units provide state-of-the-art security functionality, including live video streaming, video recording and playback, motion detection, sensor management, real-time event notification, and device activation. All of these features can be accessed remotely via PC, PDA, or cellular telephone.

The CVG-M is optimized for deployment in vehicles and other mobile platforms or remote locations in which a LAN connection is not available. It has built-in support for cable-based and cellular networking, and contains an internal GPS receiver that makes it possible to track its location and route.





Once the CVG-M has been installed as explained in this guide, it must be configured. Configuration is performed by connecting to the CVG-M unit using a PC that is on the same network as the unit (or connected to the unit directly using a LAN cross cable) and opening the unit's configuration utility in a browser. For additional information about configuring your CVG-M, please refer to the *TVG System Guide*.

Client software is used for accessing the CVG-M unit remotely in order to view video and events and control the system in various ways. SerVision offers client software for PCs and for certain cellular telephone and PDA models. Full instructions for the use of the client applications are available in separate manuals, which can be downloaded at <http://www.servision.net>.

The CVG-M Package

The CVG-M package contains the following items:

Item	Description	Illustration
CVG-M unit	Video gateway	
Power supply cable	Connects the unit to an electrical outlet	
Ethernet (LAN) cable	Connects the unit to a local network	
RS232/485 adapter *	Connects PTZ controllers or other devices to the unit	

Item	Description	Illustration
Power cord	Connects the unit to a vehicle battery via the cigarette lighter	
GPS antenna	Enables the built-in GPS receiver to connect to satellites	
Modem antenna	Enables the built-in cellular modem to connect to the internet via the cellular network	
Micro SD memory card	Stores recorded video and other data Note: The unit is supplied with the memory card in its slot.	

Additional Equipment

One or two video cameras should be connected to the CVG-M. You must acquire the cameras you require; they are not included in the CVG-M package. For information about camera compatibility and about connecting the cameras to the unit, see *Connecting Cameras*, page 13, or consult your vendor.

In addition to the cameras, you may wish to connect some or all of the optional equipment listed below to the CVG-M unit. For additional information about these items and the cables required to connect them, please refer to the installation instructions for each type of device.

NOTE: This equipment is not included in the CVG-M package.

- SIM card for the cellular network
- Dry-contact sensor, toggle (on-off) switch to change the active outline (see *Connecting Sensors*, page 15), or push-button switch to change the display in a connected CCTV monitor (see *Connecting a Switch*, page 24)
Note: A dry-contact sensor or switch can be connected directly to the **Sensor** connector on the CVG-M unit. If you use either an ADAM module or an IA relay board, as described below, you can connect an additional 16 dry-contact sensors via the unit's **RS232/485** connector.
Note: If you connect a touchscreen monitor to the CVG-M, you cannot also connect an ADAM module or an IA relay board.
- ADAM Data Acquisition Module and ADAM isolated RS232->RS422/RS485 converter, for connecting up to 16 dry-contact sensors (see *Connecting Sensors*, page 15)
- Intelligent Appliance IA-3126-2 relay board, for connecting up to 16 dry-contact sensors (see *Connecting Sensors and Activators Using an IA Relay Board*, page 20) and 16 activators to the CVG-M unit
- Dry-contact activator (an alarm or other device that is turned on or off in response to the activation of a sensor; see *Connecting an Activator*, page 19)
Note: An activator can be connected directly to the CVG-M unit. If you use an IA relay board, as described above, you can connect an additional 16 activators via the unit's **RS232/485** connector.
Note: If you connect a touchscreen monitor to the CVG-M, you cannot also connect an IA relay board. In this case, you can only connect one activator to the unit.
- Microphone (see *Connecting a Microphone*, page 21)
- Speaker or headphones (the unit already contains a built-in speaker; for additional information, please refer to the *TVG System Guide*)
- CCTV monitor for closed-circuit video display (see *Connecting a CCTV Monitor*, page 22)
- For units that will be installed in a truck or bus, an insulated container with a built-in fan in which the CVG-M unit can be placed (see *Preventing Overheating*, page 8)
- Additional micro SD cards (see *Appendix: Removing the Micro SD Card*, page 32)

Installing the CVG-M System

These are the steps that you will typically follow in order to install the CVG-M system:

1. Insert the SIM card into the SIM-card slot; see *Inserting the SIM Card*, page 25.
2. Place the CVG-M unit in its desired location; see *Selecting a Location for the Unit*, page 7.
Note: If you are installing the CVG-M in an insulated container (see *Preventing Overheating*, page 8), you must install the container in the vehicle and the CVG-M in the container.
3. Install the video cameras in their desired locations.
4. Install a CCTV monitor in its desired location (optional).
5. Install either a dry sensor, a toggle switch (for outline switching), or a push-button switch (for changing the display on a connected CCTV monitor) in its desired location (optional); see *Connecting Sensors*, page 15.
6. Install an alarm or other activator in its desired location (optional); see *Connecting an Activator*, page 19.
7. If you are using either an ADAM module to connect additional sensors to the CVG-M, install the sensors in their desired locations (optional); see *Connecting Sensors*, page 15.
8. If you are using an IA relay board to connect additional sensors or activators to the CVG-M, install them in their desired locations (optional); see *Connecting Sensors and Activators Using an IA Relay Board*, page 20.
9. Connect the cameras and other devices to the CVG-M, as required; see *Connecting Devices to the CVG-M*, page 13.
10. Connect the unit to a LAN using an Ethernet cable (optional); see *Connecting the CVG-M to a Network*, page 25.
11. Install the GPS antenna in an appropriate location in the vehicle and connect it to the unit (optional); see *Connecting the GPS Antenna*, page 27.
12. Connect the cameras and other devices to the vehicle battery, as required; see *Supplying Power to Devices Connected to the Unit*, page 10.
13. Connect the CVG-M unit to a power source; see *Connecting the CVG-M to a Power Source*, page 28.

NOTE: If the unit is being installed in a vehicle, the devices connected to it, and the cables used to connect them, must all be securely fastened to the vehicle to ensure they do not become detached from their locations when the vehicle is in motion.

NOTE: Installing the unit and its peripheral equipment in a vehicle is a complex process. It is highly recommended that it be performed by a trained specialist in vehicle installations.

Selecting a Location for the Unit

The CVG-M unit should be placed on a flat surface such as a shelf. (It is not designed for mounting directly on a wall.) If it is being installed in a vehicle, the unit should be installed in a cool and ventilated location, protected from direct sunlight and water. It should not be installed in a closed location, such as the in the trunk or dashboard, or under the paneling, of a car. Ensure the unit has at least a few centimeters (1–2 inches) of space above it and on all sides for ventilation.

When choosing a location for the CVG-M, bear in mind that the unit must be connected to a power source and a LAN or a PC, and that other devices (cameras, sensor, etc.) must be connected both to it and to power sources. If the unit will be installed in a vehicle, it must be connected to the vehicle battery and ignition (if required), and the

cellular and GPS antennas must be located relatively high up and in exposed locations (see *Connecting the Cellular Antenna*, page 25; *Connecting the GPS Antenna*, page 27) Choose a location in which these connections are feasible.

Preventing Overheating

Units that are installed in cars should be placed in the passenger compartment in a location that is cooled by the car's air-conditioning when the air conditioner is on.

Units that are installed in trucks or buses should be installed in an insulated container with a built-in fan. Containers of this type are available for purchase from vehicle-accessory suppliers. The container should be installed in the vehicle in an accessible location, with as much ventilation as possible. The ends of the cellular and GPS antennas should be placed outside the container.



Figure 1: TVG unit installed in an insulated container

Diagrams of Connectors

The rear and sides of the CVG-M unit contain the following connectors and controls.

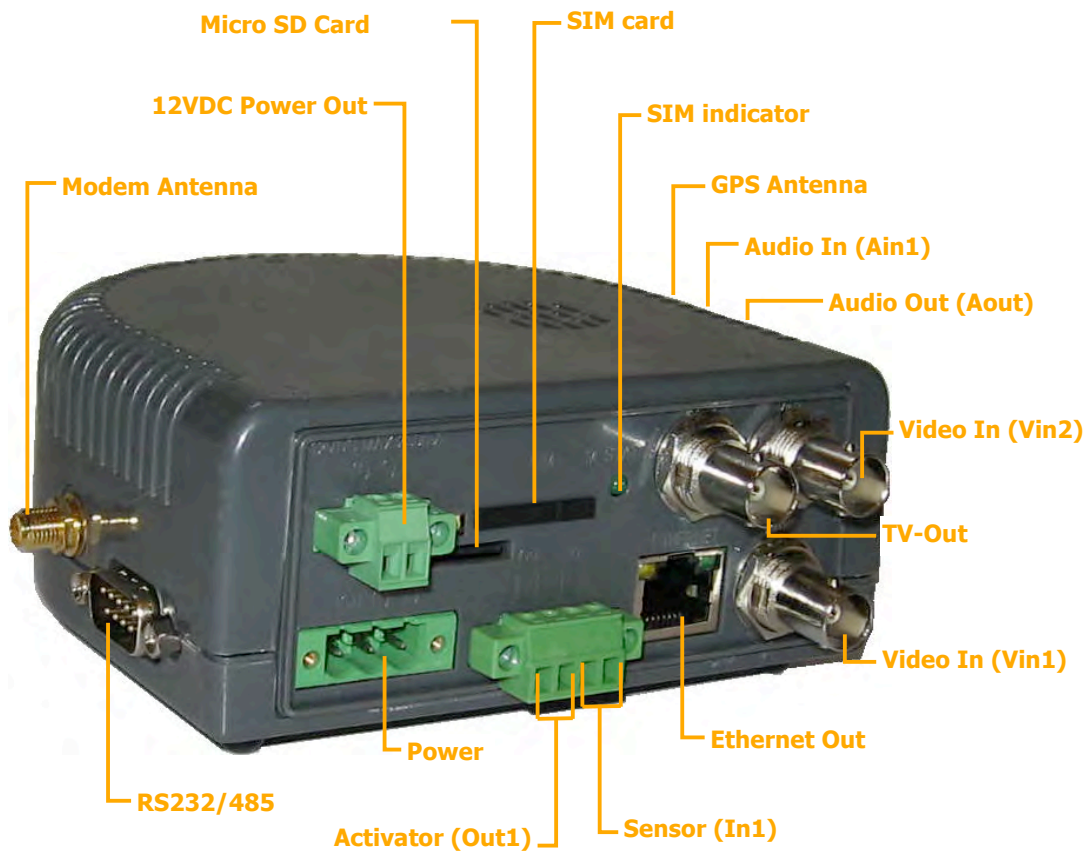

Figure 2: CVG-M connectors



Figure 3: CVG-M connectors: left panel

Connector/Control	Description
Modem Antenna	Connector for the supplied cellular-modem antenna (see page 25)
12VDC Power Out	Supplies power to external devices, such as cameras and sensors (see page 10) Note: The unit can supply up to 250 mA of power.
Micro SD Card	Slot for the micro SD card (see page 32)
SIM Card	Slot for a SIM card (see page 25)
SIM indicator	Cellular activity indicator – lit when the connection to the cellular network is active
TV Out	Connector for a CCTV monitor (see page 22)
Video In (Vin1 and Vin2)	Connectors for video cameras (see page 13)
GPS Antenna	Connector for the supplied GPS antenna (see page 27)
Audio In (Ain1)	Connector for a microphone (see page 21)
Audio Out (Aout)	Connector for an external speaker or headphones (see page 22)
Ethernet Out	10/100 Base-T LAN connector for connecting the unit to an external network (LAN or WAN; see page 25)
Sensor (In1)	Sensor connector (see page 15)
Activator (Out1)	Activator connector (see page 19)
Power	Connector for the power supply and, if required, for the ignition connection (see page 28)
RS232/485	Serial (COM) port for PTZ controllers (see page 13), a touch-screen controller (see page 22), a device to receive GPS location data (for additional information, consult your vendor), or technicians' use

Supplying Power to Devices Connected to the Unit

The CVG-M can supply power directly to cameras and other devices via the **12VDC Power Out** connector on the rear panel of the unit. However, only a limited amount of power can be supplied by the CVG-M in this way. If the devices connected to the **12VDC Power Out** connector draw too much power, the unit may overheat or otherwise malfunction. Therefore, it is best to provide independent power supplies for devices connected to the unit whenever possible by connecting them directly to a wall outlet, a battery, or the vehicle battery.

The unit can supply a maximum of 250 mA (3W at 12V) of power through the **12VDC Power Out** connector. Typically, this means it can power at most one camera. Nonetheless, you must consult the device documentation to ascertain the actual power usage of each device you want to connect to the CVG-M unit. For example, if a camera uses 150 mA and a sensor uses 50 mA, the total power usage of the two devices is 200 mA. Since the CVG-M can supply a maximum of 250 mA, this means that 50 mA are available for other devices when these two devices are connected to the **12VDC Power Out** connector on the CVG-M.

NOTE: It is, of course, possible to connect some devices to the **12VDC Power Out** connector on the CVG-M and others directly to a power source – as long as the total power consumption for the devices connected to the **12VDC Power Out** connector does not exceed 250 mA.

Turning the Device Power On and Off with the Ignition

When the CVG-M is installed in a vehicle, it is normally configured to shut down whenever the vehicle ignition is turned off. All devices that draw their power through the **12VDC Power Out** connector on the CVG-M are also turned off when the CVG-M shuts down, because they do not receive any power from the unit. If you want devices that are directly connected to the vehicle battery to also shut down when the vehicle ignition is off, you should route the power supply through the activator connector (**Out1**) on the CVG-M unit, as illustrated below.

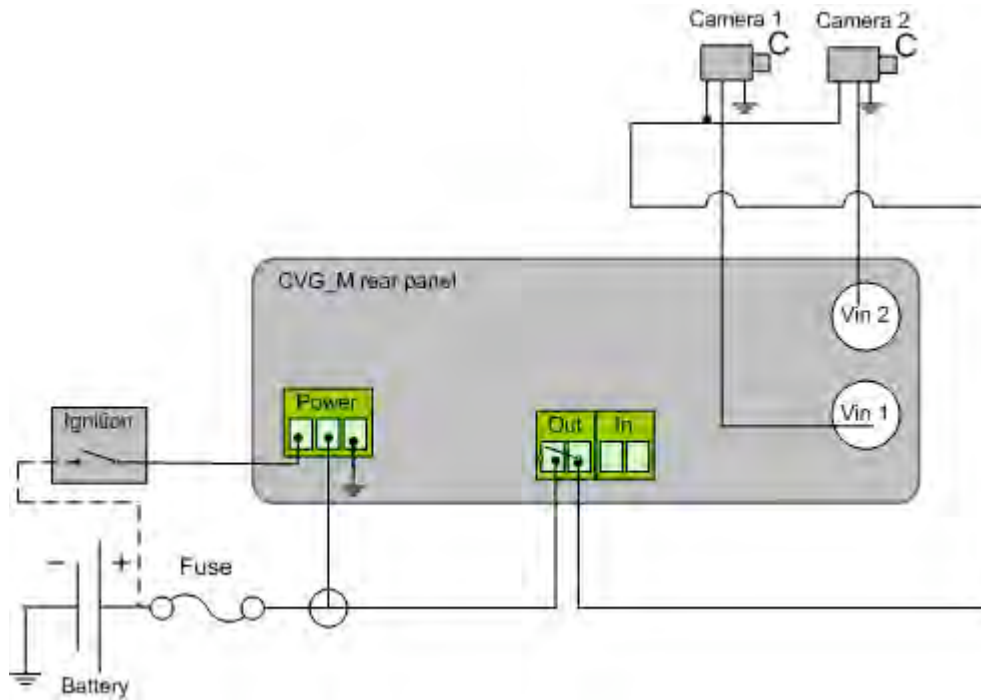

Figure 4: Connecting cameras to the power supply through the Activator connector

Transforming the Supplied Voltage to 12V

When the power supply for one or more devices is routed from the vehicle battery, you must ensure that the voltage reaching the devices is 12V. If the vehicle battery supplies power at a voltage other than 12V, you must insert a transformer between the battery and the device, as in figure 5 below.

In order to ensure that the transformer is compatible with the vehicle battery, it is recommended that it be purchased in the country in which it will be used. In addition, make sure the capacity of the transformer is more than sufficient for all of the devices connected to it. You can calculate the required capacity by calculating the sum of the power consumptions of each device drawing power from the battery through the line. For example, if two cameras and a sensor are connected directly to the battery, and each one uses 2W, the total requirement is 6W. Allow an additional margin of 20-30% when you select the transformer. Thus, if the devices require a total of 6W, get a transformer that supplies at least 7.2W.

NOTE: You can convert Amps to Watts using the following formula:

$$\text{Volts} * \text{Amps} = \text{Watts}$$

For example, a 12V device that operates at 250 mA consumes 3 Watts: $12 * 0.25 = 3$.

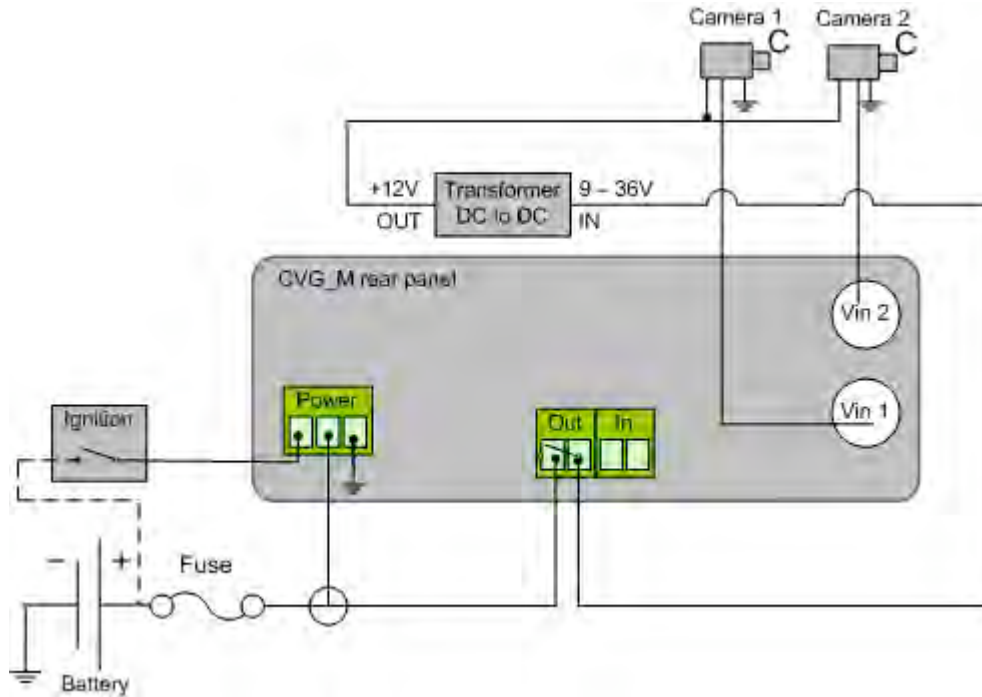
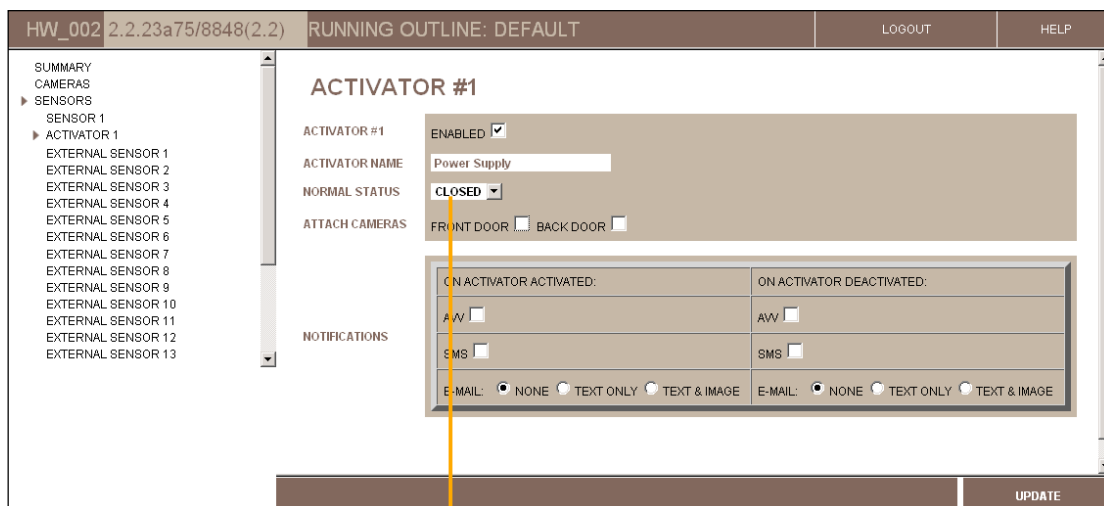

Figure 5: Placing a transformer between the vehicle battery and the devices drawing power from it

Configuring the Power-Supply Activator

When the power supply to devices is routed through the activator connector, as described above, the activator must be configured correctly in the CVG-M's configuration: the **Normal Status** of the activator must be set to **Closed**, as in the illustration below. (For additional information about configuring the activator, please refer to the *TVG System Guide*, under *Configuring Sensor and Activator Settings*.)



Normal Status

Figure 6: Normal Status of activator set to Closed

Connecting Devices to the CVG-M

This section explains how to connect devices such as cameras or a sensor to the CVG-M unit.

NOTE: If you are connecting devices to a CVG-M in a vehicle, make sure that all the devices are designed to function properly under mobile conditions (temperature range, vibrations, power supply, etc), that they are all installed in accordance with their manufacturer's requirements, and that the devices and all cables are properly installed and firmly fastened so that they will not become dislodged when the vehicle moves. It is highly recommended to consult vehicle experts before installing external devices.

Connecting Cameras

Up to two cameras can be connected to the CVG-M. If the cameras have PTZ controls for remote aiming and zooming, and the PTZ protocol they use is supported, the control cables can also be connected to the unit.

Any PAL or NTSC video camera with a composite video output can be connected to the unit. A cable with a composite video connector on one end, and a male BNC connector on the other, should be used to connect each camera to the CVG-M.

NOTE: A cable with a male RCA connector can be connected to a female BNC connector by using an RCA-to-BNC adaptor.



Figure 7: RCA-to-BNC adaptor

Cameras that are connected to the CVG-M can receive their power from the CVG-M unit through the **12VDC Power Out** connector on the rear panel of the unit. However, bear in mind that the unit can supply a maximum of 250 mA (3W) of power through this connector. Typically, this is only enough power for one camera. If the devices connected to the unit require more than this amount of power, you must power some or all of them independently by connecting them directly to a power source, as explained under *Supplying Power to Devices Connected to the Unit*, page 10.

⇒ **To connect a camera:**

1. Install the camera in its desired location.
2. Connect the output of the camera to one of the **Video In** connectors on the unit.
3. Connect the camera's power connector to a power source.

Connecting a PTZ Controller

If a camera has remote PTZ control features (pan, tilt, zoom, and/or focus), and uses a supported PTZ protocol, you can connect the control cable to the unit. Both RS232 and RS485 PTZ connection types are supported. Consult the camera documentation for information about which connection type to use.

If you want to connect the PTZ controllers of two cameras to the unit, only one of the controllers can use an RS232 connector – the other must use an RS485 connector. PTZ controllers for more than one RS232 camera cannot be connected to the unit simultaneously.

RS485 connection wires

If you connect two RS485 PTZ camera controllers, they should be daisy-chained to the **RS232/485** connector, as described below. In this case, each camera in the chain must be given a different ID number. Please refer to your camera's documentation for information about configuring its ID number. In addition, note that you can only create an RS485 daisy chain if both cameras use the same PTZ protocol. Attempting to connect cameras that use different protocols will prevent both of the cameras from working properly.

RS232 connector

⇒ **To connect an RS232 PTZ controller:**

The RS232 controller cable should end with a female 9-pin RS232 connector.

- If you are only connecting the RS232 PTZ controller to the unit, and are not connecting any RS485 PTZ controllers, plug the 9-pin RS232 connector directly into the **RS232/485** connector on the side panel of the unit.
- If you are also connecting one or two RS485 PTZ controllers to the unit, plug the 9-pin RS232 connector into the RS232/485 adapter supplied with the unit.

⇒ **To connect an RS485 PTZ controller:**

Each RS485 controller cable should end with two wires.

1. Use a wire connector to connect the wires to the RS485 connection wires of the adapter. Be sure to match the positive (+) wire of the controller cable to the positive (+ red) wire of the adapter, and the negative (-) wire of the controller cable to the negative (- grey) wire of the adapter (see figure 8).

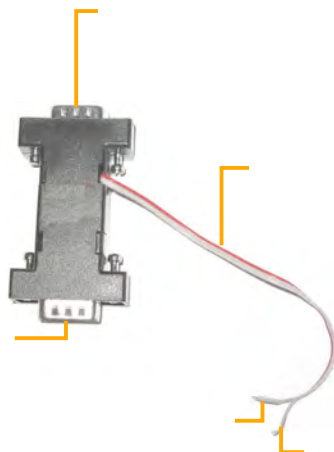

Figure 8: RS232/485 adapter

To connect two RS485 controllers to the adapter, insert the positive (+) wires of both of the controllers into one slot in the wire connector, and the negative (-) wires of both of the controllers into the other slot of the wire connector.



Figure 9: Wire connector

2. If two PTZ cameras are connected to the unit, configure each camera to use a different ID. For information about how to do this, refer to the camera documentation.
3. Connect the RS232/485 adapter to the **RS232/485** connector on the side panel of the unit.

Connecting Sensors

Input/Output terminal block

Sensors are devices that detect events such as a door being opened or a light being turned on. A dry-contact input sensor can be connected directly to the unit. Alternatively, the sensor connector on the unit can be used to connect a switch to change the active outline or the display on a connected CCTV monitor.

In addition, if you wish, you can connect either an ADAM Data Acquisition Module or an IA-3126-2 relay board to the unit. Either of these devices makes it possible to connect up to 16 additional sensors to the unit.

Connecting a Sensor Directly to the Unit

The unit has one sensor connector (**In1**). You can use this connector to connect a dry-contact input sensor to the unit. Alternatively, **In1** can be used to connect a switch for one of the following purposes:

- **Outline switch:** If you are defining more than one outline (alternate sets of recording and event-handling settings), you can connect a toggle (on-off) switch to **In1** instead of a sensor. The switch can then be used to change the active outline. For additional information, please refer to the *TVG System Guide*.

Note: Some alarm panels can also be connected to **In1**. When they are, they can function as automatic outline toggle switches. For additional information, please consult the alarm panel vendor.

- **CCTV-monitor display controller:** If a CCTV monitor will be connected to the unit, you can connect a push-button switch to **In1** instead of a sensor. The button can then be used to change the display on the monitor. For additional information, please refer to the *TVG System Guide*.

NOTE: It is possible to configure the CVG-M to use a single switch as both an outline switch and a CCTV-monitor controller, but this is not generally advisable, because it is unlikely that you will find it convenient to have the outline switched every time the CCTV display changes, and vice-versa.

⇒ To connect a sensor or switch directly to the unit:

1. Install the sensor or switch in its desired location in accordance with the manufacturer's instructions.

Note: If the sensor requires an external power supply, you may be able to connect it to the **12VDC Power Out** connector on the rear panel of the unit. However, bear in mind that the unit can supply a maximum of 250 mA (3W) of power. If the devices connected to the unit require more than this amount of power, you must power some or all of them independently (see *Supplying Power to Devices Connected to the Unit*, page 10).

2. Connect the two wire contacts of the sensor or switch to the **In1** connector on the rear panel of the CVG-M, as illustrated in figure 10. Insert the wires into the connectors and tighten the screws below each connector to hold the wires in place. It does not matter which wire you connect to each contact.

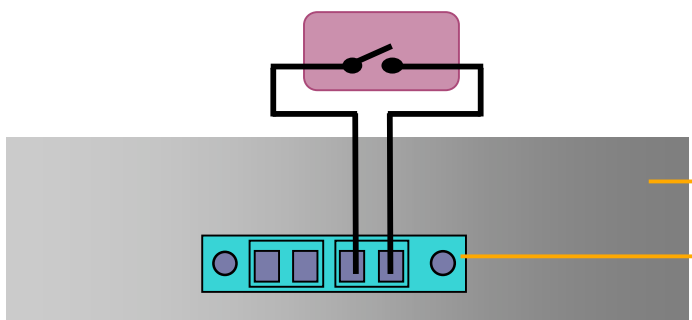

Figure 10: Connecting a sensor

Connecting Sensors Using an ADAM Module

If you want to connect additional dry sensors to the CVG-M, you can do so by connecting an ADAM Data Acquisition Module to the unit. Up to 16 additional dry sensors can then be connected to the unit through the ADAM module.

NOTE: Alternatively, you can connect additional sensors using an IA-3126-2 relay board, as explained *Connecting Sensors and Activators Using an IA Relay Board*, page 20.

To connect sensors using an ADAM module, you will need the following items:

- ADAM-4051 Data Acquisition Module (available from SerVision)
- ADAM-4520 isolated RS232->RS422/RS485 converter (available from SerVision)
- Flat ribbon cable with D-type 9-pin female connector on one end and a D-type 9-pin male connector on the other end
- Wire to connect the ADAM module to the ADAM converter – red, black, yellow, and green
- Wire and an electrical plug (optional) to connect the ADAM module to a power source (either a power supply from the unit or an independent connection)



Figure 11: ADAM-4051 module



Figure 12: ADAM-4520 isolated converter

NOTE: The instructions below explain how to connect sensors to the CVG-M using the ADAM module and converter described above. For additional information about connecting and configuring the ADAM module and converter, please refer to the manufacturer's documentation, or contact your vendor.

⇒ **To connect sensors using an ADAM module:**

1. Install the sensors in their desired locations in accordance with the manufacturer's instructions.
2. Connect the wire contacts of each of the sensors to the terminal blocks of the ADAM-4051 module as follows:
 - Connect all of the negative (-) wires of all of the sensors to one of the ground (**D GND**) connectors on the ADAM module. If the wires cannot all be inserted into the connector, use a wire connector to connect them together, and then connect the wire connector to the ground (**D GND**) connector on the ADAM module.
 - Connect each of the positive (+) sensor wires to one of the numbered connectors (**D1 0** through **D1 15**) in the terminal blocks of the module.

D GND
Connect sensor ground wires to this connector

D1 11 through D1 15
Connect positive (+) sensor wires to these connectors

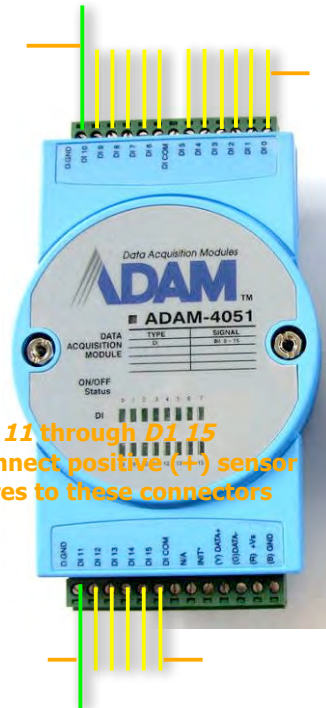

Figure 13: Connecting sensors to the ADAM-4051 module

3. Connect the ADAM-4051 module to the ADAM-4520 isolated converter as follows (see figure 15, page 19):

Connect this connector on the ADAM-4051	To this connector on the ADAM-4520
(Y) Data+	Data+
(G) Data-	Data-
(R) +Vs	(R)+Vs
(B) GND	(B)GND

4. Connect the ADAM-4520 isolated converter to the **RS232/485** connector on the rear panel of the CVG-M unit in one of the following ways:
 - If you are not connecting any RS485 PTZ controllers to the unit, using the 9-pin flat ribbon cable, connect the RS232 connector of the ADAM-4520 converter directly into the **RS232/485** connector.
 - If you are also connecting one or more RS485 PTZ controllers to the unit, using the 9-pin flat ribbon cable, connect the RS232 connector of the ADAM-4520 converter into the RS232 connector of the RS232/485 adapter supplied with the unit. Connect the PTZ controllers to the adaptor as explained under *Connecting a PTZ Controller*, page 13. Then plug the adaptor into the **RS232/485** connector on the unit.

RS232 connector

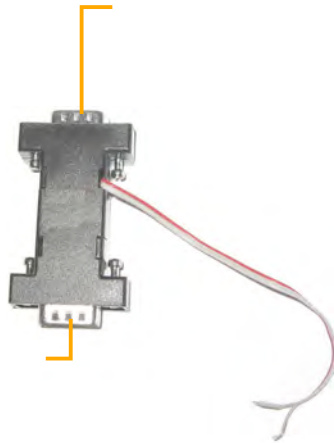

Figure 14: RS232/485 adapter

Note: If you connect an ADAM module to the unit, you cannot connect any RS232 PTZ controllers, a touch-screen controller, or an IA relay board to the unit. For additional information, see *Connecting a PTZ Controller*, page 13; *Connecting a CCTV Monitor*, page 22; *Connecting Sensors and Activators Using an IA Relay Board*, page 20.

5. Connect the ADAM-4051 module to the power source as follows (see figure 15, page 19):
 - Connect the positive (+) wire of the power supply cable to the **(R) +Vs** connector on the module
 - Connect the negative (-) wire of the power supply cable to the **(B) GND** connector on the module

Note: Each of the power connectors on the module will then have two wires connected to it – one connecting it to the power supply, and one connecting it to the power connectors of the ADAM-4520 converter.

Note: You may be able to use the CVG-M to supply power to the modules by connecting the power supply cables to the **12VDC Power Out** connector on the rear panel of the unit. However, bear in mind that the unit can supply a maximum of 250 mA (3W) of power. If the devices connected to the unit require more than this amount of power, you must power some or all of them independently (see *Supplying Power to Devices Connected to the Unit*, page 10).

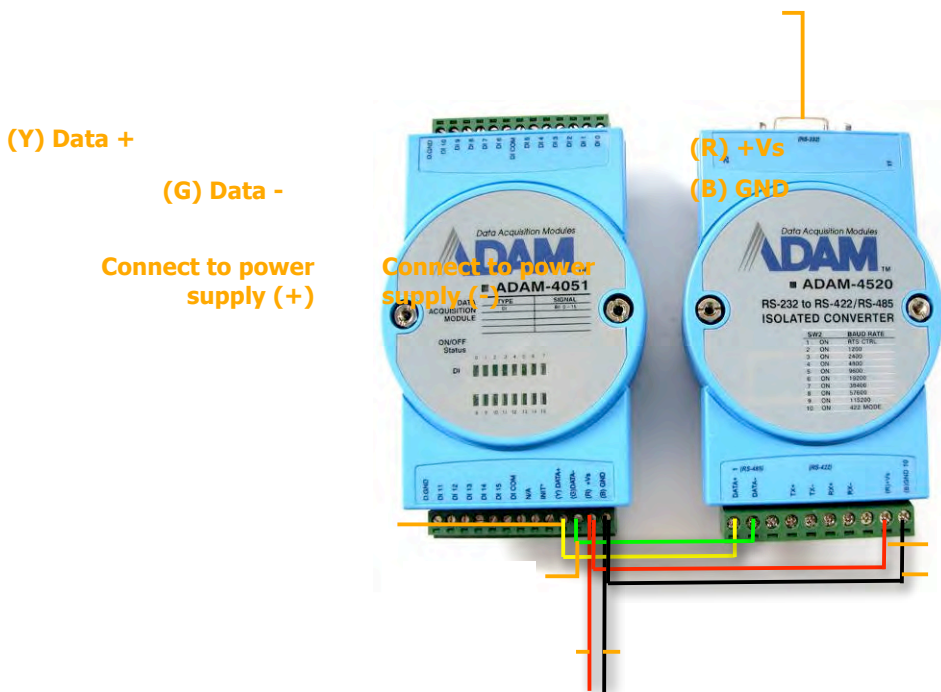

Figure 15: Connecting the module to the converter, the CVG-M, and the power supply

Connecting an Activator

Activators are external devices such as alarms and lights that can be turned on by the system in response to an event. Essentially, the unit functions as an on/off switch for the device. The unit activates the activator by closing the circuit of its power supply. One activator can be connected directly to the unit. In addition, if you wish, you can connect an IA-3126-2 relay board to the unit. This makes it possible to connect up to 16 additional activators to the unit (see *Connecting Sensors and Activators Using an IA Relay Board*, page 20).

In addition to the activator itself, you will need 16 AWG red and black cables to connect an activator to the unit.

➡ To connect an activator directly to the unit:

1. Install the activator in its desired location in accordance with the manufacturer's instructions.

Note: If the activator requires an external power supply, you may be able to connect it to the **12VDC Power Out** connector on the rear panel of the unit. However, bear in mind that the unit can supply a maximum of 250 mA of power. If the devices connected to the unit require more than this amount of power, you must power some or all of them independently. For additional information, see *Supplying Power to Devices Connected to the Unit*, page 10.

2. Connect the two contacts of the activator to the **Out1** connector on the CVG-M, as illustrated in figure 16. It does not matter which wire you connect to each contact.

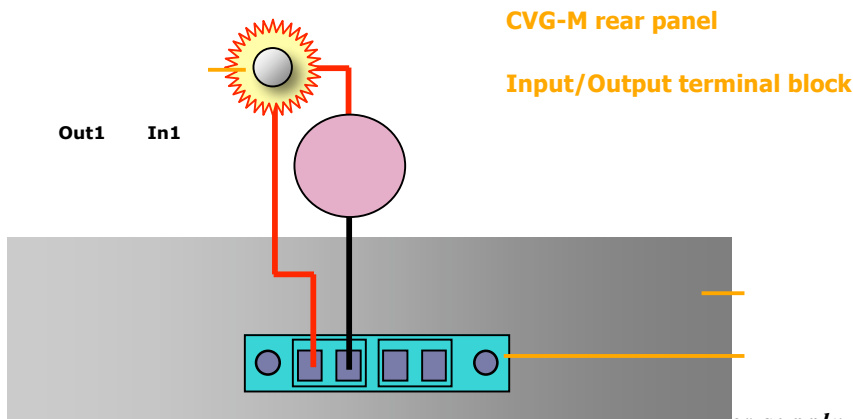

Figure 16. Connecting an activator that has its own power supply

Connecting Sensors and Activators Using an IA Relay Board

If you want to connect additional dry sensors and/or one activator to the CVG-M, you can do so by connecting an Intelligent Appliance IA 3126-2 relay board to the unit. Up to 16 additional dry sensors and 16 additional activators can then be connected to the unit through the relay board. Sensor and activator events from devices connected to an IA relay board can be seen in SerVision client applications and activators can be turned on and off via these applications. However, the sensors and activators cannot be configured using the CVG-M’s configuration utility.

NOTE: Alternatively, you can connect additional sensors using an ADAM module, as explained under *Connecting Sensors Using an ADAM Module*, page 16. Sensors that are connected through an ADAM module can be configured using the CVG-M’s configuration utility.



Figure 17: IA 3126-2 relay board

For information about connecting sensors and activators to the IA 3126-2 relay board, and about connecting the relay board to a power source, please consult the relay-board’s documentation.

NOTE: If you are connecting less than 16 activators or 16 sensors to the relay board, be sure to connect them to the relay beginning with the lowest connector, and do not leave open connectors between those that you use. For example, if you are connecting 4 activators and 3 sensors, connect the activators to output connectors 1-4 on the board and the sensors to input connectors 1-3 on the board.

RS232 connector

⇒ To connect the IA 3126-2 relay board to the CVG-M:

1. Set the ID of the relay board to 0. (For information about how to do this, consult the relay-board documentation.)
2. Connect the relay board to the **RS232/485** connector on the rear panel of the CVG-M unit in one of the following ways:
 - If you are not connecting any RS485 PTZ controllers to the unit, using a 9-pin flat ribbon cable, connect the RS232 connector of the relay board directly into the **RS232/485** connector.
 - If you are also connecting one or more RS485 PTZ controllers to the unit, using a 9-pin flat ribbon cable, connect the RS232 connector of the relay board into the RS232 connector of the RS232/485 adapter supplied with the unit. Connect the PTZ controllers to the adaptor as explained under *Connecting a PTZ Controller*, page 13. Then plug the adaptor into the **RS232/485** connector on the unit.

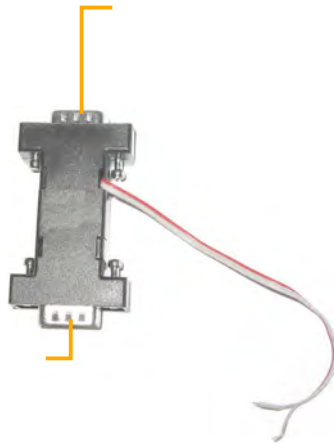

Figure 18: RS232/485 adapter

Note: If you connect a relay board to the unit, you cannot connect any RS232 PTZ controllers or an ADAM module to the unit. For additional information about connecting PTZ controllers to the unit, see *Connecting a PTZ Controller*, page 13. For information about connecting an ADAM module to the unit, see *Connecting Sensors Using an ADAM Module*, page 16.

Connecting a Microphone

A microphone can be connected to the unit. When one is connected, you can hear and record sound along with video images.

Either a passive microphone, which requires external amplification, or an active (self-amplifying) microphone, can be used. Microphones with an output voltage of 1 Vrms or 1.41 Peak are supported.

⇒ To connect a microphone:

1. Install the microphone in the desired location.
2. Plug the microphone connector into the **Audio In (Ain1)** connector on the side of the unit.

Connecting a Speaker or Headphones

The CVG-M unit contains a built-in, 1-watt, internal speaker, which is located on top of the unit. You can also connect an external speaker or headphones to the unit. The speakers (and headphones) allow you to hear audio that is transmitted from client applications. The external speaker or headphones can be used in addition to the internal speaker or instead of it. (For additional information, please refer to the *TVG System Guide*.)

Audio Out



Figure 19: Internal speaker and Audio Out connector

⇒ To connect a speaker or headphones:

1. Install the speaker in its desired location, if necessary.
2. Plug the speaker or headphone connector into the **Audio Out (Aout)** connector on the side of the unit.
3. If the speaker requires an independent power supply, connect its power supply cable to a power source.

Note: If the speaker requires an external power supply, you may be able to connect it to the **12VDC Power Out** connector on the rear panel of the unit. However, bear in mind that the unit can supply a maximum of 250 mA of power. If the devices connected to the unit require more than this amount of power, you must power some or all of them independently.

Connecting a CCTV Monitor

A CCTV monitor can be connected to the CVG-M unit. The monitor offers an alternative way to view live video from the CVG-M. It is primarily useful if you want to view video when the user is near the unit. For example, if the CVG-M is set up in a bus, the driver can use a CCTV monitor to keep tabs on parts of the bus that cannot be seen from the driver's seat.

The following types of monitors can be used:

- Surveillance monitors: Monitors that are designed to be plugged directly into surveillance cameras.
- Entertainment monitors: Monitors that are intended to be plugged into portable DVD players in vehicles.
- Standard television sets with AV connectors

When choosing a monitor to connect to the unit, ensure the monitor supports the video format used by the cameras (NTSC or PAL). Some SECAM monitors will also work when the PAL video format is used.

If you choose a monitor with touchscreen support, you can use the monitor to view recorded video as well as live video. For information about recommended types of touchscreen monitors, please consult your vendor.

NOTE: If you are connecting an RS232 PTZ controller to the unit, you cannot use touchscreen functionality because the RS232 serial port is not available. For additional information, see *Connecting a PTZ Controller*, page 13.

RS232 connector

To connect the monitor to the CVG-M, you will need a cable with the following connectors:

- An appropriate connector (BNC or RCA) for the Video In connector of the monitor. (Consult the monitor documentation or your vendor to find out which kind of connector is required for the particular monitor you are using.)
- A BNC male connector to connect to the **TV Out** connector of the CVG-M. (A cable with an RCA connector can be used by attaching a BNC-to-RCA adaptor to the connector. See figure 7, page 13.)

To connect the output of a touchscreen to the unit, you will need a cable with the following connectors:

- An appropriate connector to connect to the touch output connector on the monitor
- A female 9-pin RS232 connector to connect to the CVG-M's **RS232/485** connector.

An appropriate cable should be supplied with the monitor.

⇒ **To connect a CCTV monitor:**

1. Install the monitor in its desired location.
2. Connect the Video In connector of the monitor to the **TV Out** connector of the CVG-M, using a cable with an appropriate connector (BNC or RCA) for the Video In connector of the monitor on one end, and a BNC male connector on the other end.

Note: If you are using a standard television set as a monitor, use the television's AV connector as the Video Input connector.

3. If the monitor is touch-sensitive, connect the touch output to the **RS232/485** connector as follows:
 - If you are not connecting any RS485 PTZ controllers to the unit, connect the RS232 connector of the touch output cable directly into the **RS232/485** connector.
 - If you are also connecting one or more RS485 PTZ controllers to the unit, connect the RS232 connector of the touch output cable to the RS232 connector of the RS232/485 adaptor supplied with the unit (see figure 20 below). Connect the PTZ controllers to the adaptor as explained under *Connecting a PTZ Controller*, page 13. Then plug the adaptor into the **RS232/485** connector on the unit.

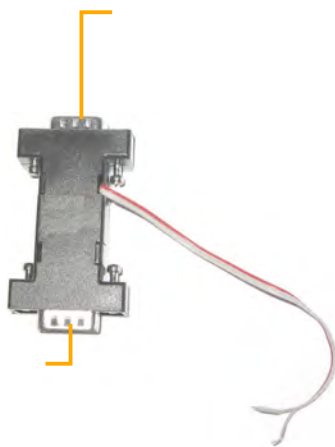

Figure 20: RS232/485 adapter

4. If the monitor is touch-sensitive, it is recommended that you calibrate it before you use it. For information about how to calibrate the monitor, please refer to the monitor's documentation.

Connecting a Switch

If you wish, you can connect a switch to the unit to change the display on the monitor. The switch must be connected to the **In1** connector. For additional information, see *Connecting Sensors*, page 15, and refer to the *TVG System Guide*.

Connecting Multiple Monitors

If you wish, you can connect multiple CCTV monitors to the CVG-M. For example, you may wish to have one monitor beside the driver's seat and another beside the conductor's seat.

To connect multiple monitors, you must use video splitters to split the connection. Bear in mind, however, that the image quality in each of the monitors will be slightly degraded. To correct this problem, you can use a video amplifier (booster) for each monitor. To ensure you have the correct equipment, consult a video equipment supplier.

Connecting the CVG-M to a Network

The CVG-M can be connected to a local network using a network cable. Once connected, it can be accessed either from a PC on the same LAN network or via the internet through the LAN's *gateway* (router). The unit also contains a cellular modem that allows it to connect wirelessly to a cellular network and, through the cellular network, to the internet. A cable-based network connection should be used to access the CVG-M unit when it is first set up in order to configure it. Once it is set up, either type of network connection can be used. For information about configuring the network settings so that you can connect to the unit, please refer to the *TVG System Guide*.

LAN Connection

You can connect the CVG-M to a cable-based LAN. When the unit is connected to a LAN, it cannot connect to a cellular network.

⇒ **To connect the CVG-M unit to a LAN:**

- Connect the **Ethernet Out** connector on the CVG-M unit to a LAN connection point (a hub, wall socket, or any other connection point) using the supplied Ethernet cable (see *The CVG-M Package*, page 4).

Cellular Connection

The CVG-M can connect to the internet using a built-in 3G GSM UMTS/HSDPA cellular modem. In order to use this feature, you must acquire an appropriate SIM card from a cellular provider and insert the SIM card into the unit. Once the SIM card is inserted, the unit is configured to use it, and the cellular antenna is connected, the CVG-M can transmit video streams, event information, and GPS location data to client applications from any location in which the relevant cellular network can be accessed.

If a SIM card is installed in the CVG-M and properly configured, the unit automatically attempts to connect to the cellular network. Nevertheless, the unit can only connect to one network at a time, and it gives priority to a LAN connection. Thus, if the unit is already connected to a LAN, it will not attempt to connect to the cellular network when you insert a SIM card. On the other hand, if it is already connected to a cellular network, and you connect it to a LAN, it will automatically disconnect from the cellular network and connect to the LAN.

Connecting the Cellular Antenna

The supplied cellular antenna must be connected to the CVG-M in order for it to connect to a cellular network.

⇒ **To connect the cellular antenna:**

1. Screw the connector on the end of the antenna wire to the **Cellular Antenna** connector on the side of the unit.
2. Place the other end of the antenna as high up as possible, minimizing obstructions between it and the sky. If the unit is installed in a vehicle, make sure the antenna is attached securely to the vehicle so that it will not come loose when the vehicle moves.

Inserting the SIM Card

You must insert a SIM card in the CVG-M in order for it to connect to a cellular network.

NOTE: If the SIM card requires a PIN, configure the modem settings as described in the *TVG System Guide* before you insert the SIM card into the unit. Otherwise, the unit may attempt to use the SIM card to connect to the network with an incorrect PIN. Attempts to use the SIM with an invalid PIN may cause the SIM card to be locked.

Align clipped corner of SIM card here**⇒ To insert a SIM card into the unit:**

1. Using the tip of a paper clip, a ball-point pen, or a similar item, firmly press the release button at the side of the SIM-card slot on the rear of the CVG-M. The SIM-card holder pops partway out of the slot.

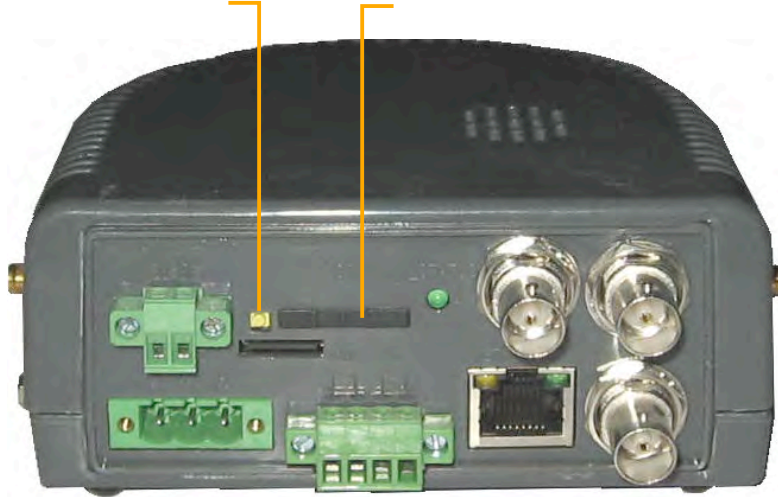

Figure 21: SIM-card slot and release button

2. Pull the holder out of the unit and turn it over.
3. Place the SIM card in the holder. (The SIM card can only fit in the holder in one direction; the clipped corner of the SIM card lines up with one corner of the holder.) The card snaps into place.



Figure 22: SIM-card holder

4. Turn the holder over (so that the SIM card faces down) and push the holder back into the slot.

Connecting the GPS Antenna

A GPS receiver is built into the CVG-M unit. When the GPS antenna is connected to the unit, this receiver can be used to track the location of a vehicle in which the CVG-M is installed.

⇒ **To connect the GPS antenna:**

1. Connect the supplied GPS antenna cable to the **GPS Antenna** connector on the side of the unit.
2. Place the other end of the antenna as high up as possible in the vehicle or on the roof of the vehicle. Make sure the box at the end of the antenna is horizontal and is facing up (smaller side up). If possible, place it in a location in which there are no obstructions between it and the sky.



Figure 23: GPS antenna cable

The box at the end of the antenna contains a magnet with which you may be able to attach it to the roof of the vehicle. Alternatively, you can attach it in its intended location with double-sided tape. Regardless of which method you use, make sure the antenna is attached securely to the vehicle so that it will not come loose when the vehicle moves.

Power LED

Connecting the CVG-M to a Power Source

The CVG-M can be connected either to an electrical outlet using the supplied power-supply cable, or to the ignition of a vehicle, using the supplied power cord.

Once it is connected, the unit starts up automatically. During the start-up process, the **Power LED** on the top of the unit flashes at various intervals. When the start-up process is completed successfully, the **Power LED** should display as a solid color and blink momentarily every second. (Depending on the configuration settings, it should either be solid orange and then blink green or solid green and then blink orange.)



Figure 24: Power LED

NOTE: When the start-up process is completed, if the **Power LED** does not flash – it displays as a solid green or orange all the time – the start-up process was not successful. In this case, disconnect the unit from the power supply and then reconnect it.

Connecting the CVG-M to a Vehicle Battery

Normally, the unit is connected to a vehicle battery and to the ignition using 16 AWG cable (not supplied). This can be done in one of two ways:

- Connecting the unit directly to the battery and the ignition
- Connecting the unit to a power source in the vehicle that is only active when the ignition is on

When the unit is connected to the battery and ignition in one of these ways, it automatically powers up when the ignition is switched on. If the unit is connected directly to the battery, it can be configured to operate only when the vehicle ignition is on and to shut down automatically soon after the ignition is turned off. Otherwise, it will shut down automatically when the ignition is turned off.

For testing and evaluation purposes, the unit can also be powered by connecting it to the vehicle's cigarette lighter, if the vehicle has one. This method connects the unit to the battery and the ignition quickly and easily, but it is not normally suitable for permanent connections, because it is difficult to install the unit and the wiring securely in appropriate locations when this method is used.

In addition, it is possible to connect the unit to the battery alone, without connecting it to the ignition. In this case, the unit runs continuously, whether the ignition is on or not, as long as the battery can supply power to it. Because of the drain on the battery, connecting the unit in this way is also only recommended for limited periods of time for testing and evaluation purposes.

NOTE: The ignition connector (**IGN**) of the **Power** connector **MUST** be connected. If it is not, the unit will not start. If you wish to use the vehicle's ignition connection, connect it to this connector. Otherwise, short this connection to the positive (+) connector of the **Power** connector block. For additional information, see step 5 below (pp. 29–30).

NOTE: To connect the unit only to the battery, 16 AWG red and black cable (not supplied) is required.

NOTE: It is recommended that only a vehicle-installation specialist connect the unit to the battery.

⇒ **To connect the CVG-M to a vehicle battery:**

1. Remove the wire connector from the end of the supplied power cord.



Figure 25: Wire connector

2. Plug the wire connector into the **Power** connector on the rear panel of the unit and tighten the screws to secure it.

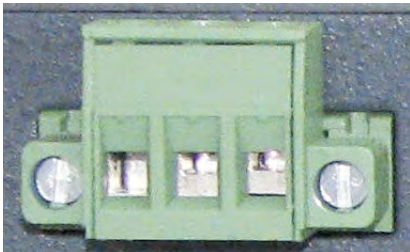

Figure 26: Wire connector plugged into Power connector

3. Using 16 AWG red cable, connect the unit to the vehicle battery as follows:
 - Connect one end of the red wire to the positive (+) connector of the Power wire connector (the middle connector in the block).
 - Connect the other end of the red wire to the positive (+) connector of the vehicle battery or power source
4. Using 16 AWG black cable, connect the unit to the vehicle battery as follows:
 - Connect one end of the black wire to the negative (-) connector of the Power wire connector (the right connector in the block).
 - Connect the other end of the black wire to the negative (-) connector of the vehicle battery or power source
5. If you need to connect the unit to the ignition, using 16 AWG black cable, connect the **IGN** connector to the ignition, as illustrated in figure 27. If you do not need to connect the unit to the ignition, using 16 AWG black cable, connect the **IGN** connector to the positive (+) connector of the **Power** wire connector (the middle connector in the block), as illustrated in figure 28.

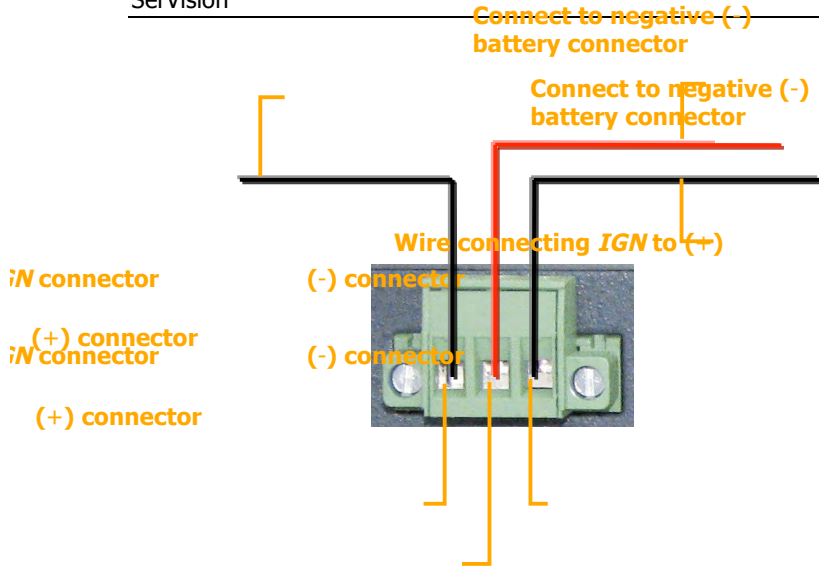

Figure 27: Connecting the CVG-M to the vehicle battery and the ignition

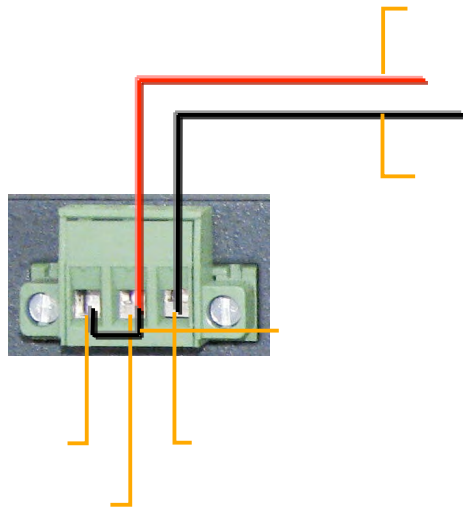

Figure 28: Connecting the IGN connector to the (+) connector when a connection to the ignition is not required

⇒ **To connect the CVG-M to a vehicle's cigarette lighter:**

- Use the supplied power cord to connect the **Power** connector on the rear panel of the unit to the vehicle's cigarette lighter.



Figure 29: Power cord

Connecting the CVG-M to an Electrical Outlet

Connect to the power connector on the CVG-M

If a standard electrical outlet is available, the unit can be connected to it. If the unit is being installed in a building, or you want to configure or test the unit indoors, you can power the unit in this way. The power-supply cable has a built-in switch. The switch mimics the ignition switch of a vehicle: when the switch is in the ON position, the "ignition" is on, and when it is in the OFF position, the "ignition" is off.

WARNING: Only the power supply cable that came with the unit should be used to connect the unit to an electrical outlet. Use of a power supply other than the one provided in the package may cause irreparable damage to the unit.

⇒ To connect the CVG-M to a standard electrical outlet:

1. Use the supplied power supply cable to connect the **Power** connector to the outlet.



Figure 30: Power supply cable

2. Push the switch on the cable to the ON position. The "ignition" is on.

Appendix: Removing the Micro SD Card

The CVG-M unit stores all recorded video and event information on a standard micro SD card. The unit is supplied with a 4 GB micro SD card. You can remove this card from the unit in order to copy video files from it and/or replace it with a different micro SD card.

NOTE: The CVG-M cannot record video or event information unless an appropriate micro SD card is in the card slot.

NOTE: SerVision provides a software application for downloading recorded video and other data from a micro SD card. The software can be downloaded from the SerVision website (<http://www.servision.net>). Once the data is downloaded, you can view it in the MultiClient. For additional information, please contact SerVision technical support.

Removing the Micro SD Card from the Unit

You can remove the micro SD card from the CVG-M unit.

⇒ To remove the micro SD card:

1. Press the edge of the card that protrudes slightly from the card slot. The card pops partway out of the slot.

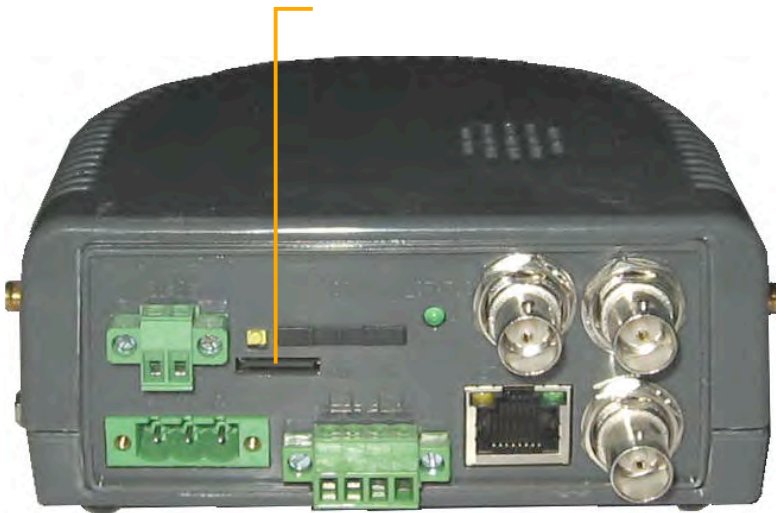

Figure 31: Removing the micro SD card

2. Pull the card out of the slot.

Inserting a Micro SD Card into the Unit

You can reinsert the supplied micro SD card or a different micro SD card into the CVG-M unit.

➡ **To insert a micro SD card into the unit:**

- Hold the card as illustrated below and push it gently into the card slot until it clicks into place.



Figure 32: Micro SD card

SerVision

POB 45205 Jerusalem 91450 Israel

Tel: +972-2-535 0000 • Fax: +972-2-586 8683

www.servision.net • info@servision.net